

ALTO[®]

CLARKE
TECHNOLOGY

Operator's Manual

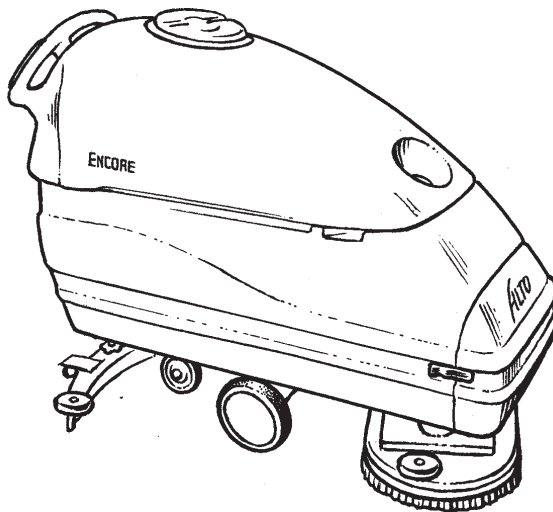

ENCORE
S2426/L2426

U.S. Patent No. 6,105,192; No. 6,557,207; No. 6,760,947; No. 6,763,544; No. 5,383,251

READ THIS BOOK

▲ CAUTION: Read the Operator's Manual before using the appliance.

This book has important information for the use and safe operation of this machine. Failure to read this book prior to operating or attempting any service or maintenance procedure to your ALTO machine could result in injury to you or to other personnel; damage to the machine or to other property could occur as well. You must have training in the operation of this machine before using it. If operator(s) cannot read this manual, have it explained fully before attempting to operate this machine.

Si Ud. o sus operadores no pueden leer el Inglés, se hagan explicar este manual completamente antes de tratar el manejo o servicio de esta máquina.

All directions given in this book are as seen from the operator's position at the rear of the machine.

For new books write to: ALTO U.S. Inc., 2100 Highway 265, Springdale, Arkansas 72764.

Table of Contents

| | |
|--|----|
| Operator Safety Instructions | 3 |
| Introduction & Machine Specifications | 5 |
| Procedures for Transporting Machine | 6 |
| Symbols Used on Encore S2426 and L2426 | 8 |
| Machine Control Panel | 10 |
| Machine Controls and Features | 11 |
| How to Prepare the Machine for Operation | 12 |
| How to Install the Batteries | 12 |
| Battery Maintenance | 13 |
| How to Charge the Batteries | 14 |
| How to Adjust Brush Cleaning Path | 15 |
| How to Install a Brush or Pad Driver | 15 |
| How to Remove a Brush or Pad Driver | 16 |
| How to Operate the Machine | 16 |
| How to Operate the Squeegee | 16 |
| Filling the Solution Tank | 16 |
| Operating the Machine | 17 |
| How to Clean a Dirty Floor | 18 |
| Maintenance | 19 |
| Procedures Before Work is Began | 19 |
| Procedures to Perform at the End of Work | 20 |
| Procedures to Perform Every Week | 21 |
| Maintenance for the Squeegee | 22 |
| How to Adjust the Squeegee | 22 |
| How to Center or Off set Brushhead | 23 |
| Accessories | 24 |

SECTION II - Parts and Service Manual



| | |
|--|----|
| How to Correct Problems in the Machine | 26 |
| Encore S2426/L2426 Final Assembly Drawing | 28 |
| Parts List | 29 |
| Recovery Tank Drawing | 30 |
| Parts List | 31 |
| Solution Tank Assembly Drawing | 32 |
| Parts List | 33 |
| Rear Panel Assembly Drawing | 34 |
| Parts List | 35 |
| Control Panel Assembly Drawing | 36 |
| Parts List | 37 |
| Squeegee Lift Assembly Drawing | 38 |
| Parts List | 39 |
| Squeegee Assembly Drawing | 40 |
| Parts List | 41 |
| Frame Axle Assembly Drawing | 42 |
| Parts List | 43 |
| Brush Head Assembly Drawing | 44 |
| Parts List | 45 |
| Optional Brake Assembly Drawing and Parts List "S" Model | 46 |
| Optional Brake Assembly Drawing and Parts List "L" Model | 47 |
| Vacuum Motor Drawing and Parts List | 48 |
| Gearbox Assembly Drawing and Parts List | 49 |
| Brush Motor Assembly Drawing and Parts List | 50 |
| Transaxle Repair Parts | 51 |
| Battery Charger Drawing and Parts List | 52 |
| Encore S2426 Connection Diagram | 53 |
| Encore S2426 Electrical Schematic | 54 |
| Encore L2426 Connection Diagram | 55 |
| Encore L2426 Electrical Schematic | 56 |









OPERATOR SAFETY INSTRUCTIONS











 **WARNING**

 **AVERTISSEMENT**

 **ADVERTENCIA**

-  **DANGER:** Failure to read and observe all **DANGER** statements could result in severe bodily injury or death. Read and observe all **DANGER** statements found in your Owner's Manual and on your machine.
-  **WARNING:** Failure to read and observe all **WARNING** statements could result in injury to you or to other personnel; property damage could occur as well. Read and observe all **WARNING** statements found in your Owner's Manual and on your machine.
-  **CAUTION:** Failure to read and observe all **CAUTION** statements could result in damage to the machine or to other property. Read and observe all **CAUTION** statements found in our Owner's Manual and on your machine.

-  **DANGER:** Failure to read the Owner's Manual prior to operating or attempting any service or maintenance procedure to your Clarke Technology machine could result in injury to you or to other personnel; damage to the machine or to other property could occur as well. You must have training in the operation of this machine before using it. If you or your operator(s) cannot read English, have this manual explained fully before attempting to operate this machine.
-  **DANGER:** Operating a machine that is not completely or fully assembled could result in injury or property damage. Do not operate this machine unless it is completely assembled. Inspect the machine carefully before operation.
-  **DANGER:** Machines can cause an explosion when operated near flammable materials and vapors. Do not use this machine with or near fuels, grain dust, solvents, thinners, or other flammable materials. This machine is not suitable for picking up hazardous dust. Use only commercially available floor cleaning waxes intended for machine operation.
-  **DANGER:** Lead acid batteries generate gases which can cause an explosion. Keep sparks and flames away from batteries. Do not smoke around the machine. Charge the batteries only in an area with good ventilation. Make sure that the AC charger plug is unplugged from the wall receptacle before connecting or disconnecting the DC plug to or from the battery pack.
-  **DANGER:** Working with batteries can be dangerous! Always wear eye protection and protective clothing when working near batteries. Remove all jewelry. Do not put tools or other metal objects across the battery terminals, or the tops of the batteries.
-  **DANGER:** Using a charger with a damaged power cord could result in an electrocution. Do not use the charger if the power cord is damaged.
-  **WARNING:** Operating this machine from anywhere other than the back of the machine could result in injury or damage. Operate this machine only from the rear.
-  **WARNING:** This machine is heavy. Get assistance before attempting to transport or move it. Use two able persons to move the machine on a ramp or incline. Always move slowly. Do not turn the machine on a ramp. Do not use on surfaces having a gradient exceeding that marked on the appliance. Read the "Procedures For Transporting" in this manual before transporting as machine might topple over if not secured.
-  **WARNING:** Machines can topple over and cause injury or damage if guided over the edges of stairs or loading docks. Stop and leave this machine only on a level surface. When you stop the machine, put all switches into their "OFF" position. Turn the key switch "OFF" and remove the key.

-  **WARNING:** Maintenance and repairs performed by unauthorized personnel could result in damage or injury. Maintenance and repairs must be performed by authorized Clarke Technology personnel only.
-  **WARNING:** Any alterations or modifications of this machine could result in damage to the machine or injury to the operator or other bystanders. Alterations or modifications not authorized by the manufacturer voids any and all warranties and liabilities.
-  **WARNING:** Electrical components of this machine can "short-out" if exposed to water or moisture. Keep the electrical components of the machine dry. Wipe the machine down after each use. This appliance is for dry use only and is not to be used or stored outdoors in wet conditions.
-  **WARNING:** Operating a machine without observing all labels and instructional information could result in injury or damage. Read all machine labels before attempting to operate. Make sure all of the labels and instructional information are attached or fastened to the machine. Get replacement labels and decals from your Clarke Technology distributor.
-  **WARNING:** Wet floor surfaces can be slippery. Water solutions or cleaning materials used with this type of machine can leave wet areas on the floor surface. These areas can cause a dangerous condition for the operator or other persons. Always put "Caution" signs around/near the area you are cleaning.
-  **WARNING:** Improper discharge of waste water may damage the environment and be illegal. The United States Environmental Protection Agency has established certain regulations regarding discharge of waste water. City, state and national regulations regarding this discharge may also be in effect in your area. Understand and follow the regulations in your area. Be aware of the environment hazards of chemicals that you dispose.
-  **WARNING:** Only use the brushes provided with the appliance or those specified in the Operator's Manual. The use of other brushes may impair safety.
-  **CAUTION:** Use of this machine to move other objects or to climb on could result in injury or damage. Do not use this machine as a step or furniture. Do not ride on this machine.
-  **CAUTION:** Your machine warranty will be voided if anything other than genuine Clarke Technology parts are used on your machine. Always use Clarke Technology parts for replacement.
-  **CAUTION:** This machine contains lead acid batteries. The batteries must be disposed of in an environmentally acceptable manner.

English *Correct Disposal of This Product (Waste Electrical & Electronic Equipment)*
(Applicable in the European Union and other European countries with separate collection systems)



This marking shown on the product or its literature, indicates that it should not be disposed with other household wastes at the end of its working life. To prevent possible harm to the environment or human health from uncontrolled waste disposal, please separate this from other types of wastes and recycle it responsibly to promote the sustainable reuse of material resources. Household users should contact either the retailer where they purchased this product, or their local government office, for details of where and how they can take this item for environmentally safe recycling.

Business users should contact their supplier and check the terms and conditions of the purchase contract. This product should not be mixed with other commercial wastes for disposal.

Introduction & Machine Specifications

Introduction & Machine Specifications

Clarke Technology's newly designed Encore S2426 and L2426 automatic scrubbers are efficient and superior floor cleaning machines. The Encore uses two brushes to scrub a path 24 or 26 inches wide. A squeegee wipes the floor while the vacuum motor removes the dirty solution from the floor - all in one pass.

The Encore S2426 comes complete with either four - 6 volt batteries or two - 12 volt batteries, one battery charger, either two brushes or two pad drivers, and one operator's manual.

The Encore L2426 comes complete with four - 6 volt batteries, one battery charger, either two brushes or two pad drivers, and one operator's manual.

SPECIFICATIONS:

| Model | Encore L2426 | Encore S2426 |
|--|---|---|
| Machine Power Supply | 24 Volt D.C., (4) 6V 250 AH Deep Cycle Batteries or (4) 6V 330 AH Deep Cycle Batteries | 24 Volt D.C., (2) 6V 195 AH Deep Cycle Batteries or (4) 6V 250 AH Deep Cycle Batteries or (4) 6V 330 AH Deep Cycle Batteries |
| Pad or Brush 2 per machine | Gimbal Style | 3-Lug Driver Style |
| Traverse | 0.5 hp (0.4 kW) Transaxle | Brush Assist |
| Traverse Forward Speed | Variable to 250 ft./min (76 m/min) | Not Applicable |
| Traverse Reverse Speed | Variable to 190 ft./min. (58 m/min) | Not Applicable |
| Battery Protection | Low Voltage | |
| Motor Vacuum | 3/4 HP, 3 stage, Acoustical High Efficient Tangential | |
| Solution Tank | 20 Gallons (76 liters) | |
| Solution Level | Calibrated level indicator on rear of machine | |
| Recovery Tank | 20 Gallons (76 liters) | |
| Recovery Full Indicator | Electric Shut-Off | |
| Parabolic Squeegee | Swing type with breakaway feature, No tool operation feature 32 inches (81 cm) hard width with 34 inches (86 cm) flex blade width. | |
| Squeegee Operation | Reverse direction on floor and 3 - position manual lever style operation | |
| Cleaning Swath | 24 or 26 inch (61 or 66 cm) adjustable head | |
| Motor, Brush | 0.75 HP (0,56 kW) 5.2:1 High Torque Gear Box | |
| Brush / Pad Size | (2) 13 inch (33 cm) | |
| Brush Speed | 200 RPM | |
| Brush Pressure | 0-150 lbs. / 0-68 kg. | |
| Brush Solution Retention | Fiber Bristles | |
| Drive Wheels | (2) 8 in. x 2 in. (20 cm x 5 cm) Neoprene tread | |
| Caster | Dual 4 in. x 2 in. (10 cm x 5 cm) | |
| Charger | 24 V D.C., 25 Amp, 115/60 or 24 V D.C., 25 Amp, 230/50 | |
| Grade Cleaning | 5 Degree (6%) | 2% |
| Length | 56 inches (142 cm) | |
| Width | 28 inches (71 cm) | |
| Height | 43 inches (109 cm) | |
| Weight | 871 lb / 395 kg | |
| Line of Sight (from Operator Height): 68 inches (173 cm) | 7.5 feet (2.3 m) | |
| Warranty | Machine 3 Years, Polydur tanks- 8 years Batteries- 18 months, pro-rated | |
| Noise | 71 dBA | 71 dBA |
| Vibration | < 2.5 m/s ² | < 2.5 m/s ² |

Procedures For Transporting

How to Put the Machine Into a Van or Truck

⚠ WARNING: This machine is heavy. Get assistance before attempting to transport or move it. Use two able persons to move the machine on a ramp or incline. Always move slowly. Do not turn the machine on a ramp. Do not stop and leave the machine on a ramp or incline. The loading ramp must be a minimum of 32" wide.

⚠ WARNING: Machines can topple over if guided over the edges of stairs or loading docks and cause injury or damage. Stop and leave this machine only on a level surface. When you stop the machine, put all switches into their "OFF" position.

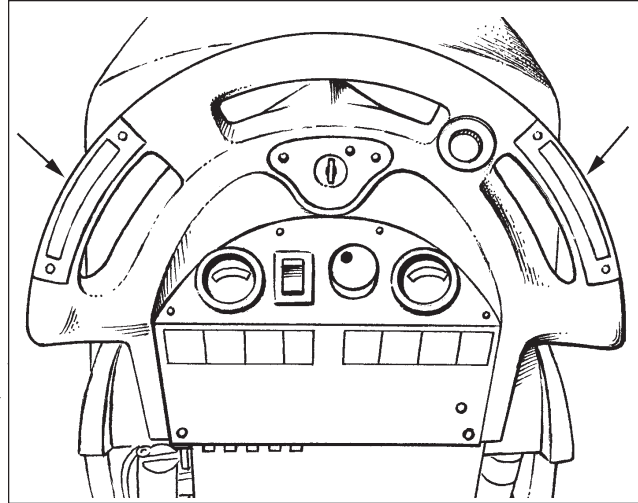

Figure #1

1. Make sure the loading ramp is at least eight (8) feet (2.5m) long and a minimum of 32" (0.8m) wide, and strong enough to support the machine.
2. Make sure the ramp is clean and dry.
3. Put the ramp in position.
4. Remove squeegee assembly, brush housing and brush or pad driver before loading. ALTO recommends that both the solution tank and recovery tank are empty before loading.
5. Turn key switch "ON" (on L2426 model only).
6. Align the machine on a level surface five (5) feet (2 m) in front of the ramp.
7. Put the traverse knob at full speed (on L2426 model only).
8. For the L2426 machine, push in either one of the forward/reverse switches while pushing in the white reverse switch. Back the machine up the ramp. See figure 1.
9. For the S2426 machine, push the machine backwards to the top of the ramp.
10. Turn the key switch "OFF".

Procedures For Transpoting (cont.)

11. **Fasten the machine to the vehicle.** Clarke Technology recommends a strap over the top of the machine and a strap to keep the machine from rolling forward or backwards. If this is not done, there is a possibility of the machine toppling over. Four tie down points (2 along each side of frame) are provided on machine for securing machine.

How to Remove the Machine From a Van or Truck

1. Make sure there are no obstructions in the area.
2. Make sure the unloading ramp is at least eight (8) feet (2.5m) long and a minimum of 32" (0.8m) wide, and strong enough to support the machine.
3. Make sure the ramp is clean and dry.
4. Put the ramp in position.
5. Unfasten the machine.

⚠ WARNING: The machine is heavy. Make sure you use two able persons to assist in moving the machine down the ramp.

6. On S2426 model, get two people to pull machine off ramp. It is recommended that the "S" model be unloaded in the forward position.
7. Turn the key switch "ON". (L2426 model only)
8. Set the traverse center knob to the slowest forward speed setting. Carefully and slowly, drive the machine to the top of the ramp and start down.
9. While pushing in the right or left forward/reverse switch the machine will go forward. See figure 2.
10. As the machine begins to travel down the ramp, push in the forward/reverse switch to maintain a slow downward speed.
11. Replace squeegee assembly, brush housing, and brush or pad driver after machine is unloaded and ready to use.

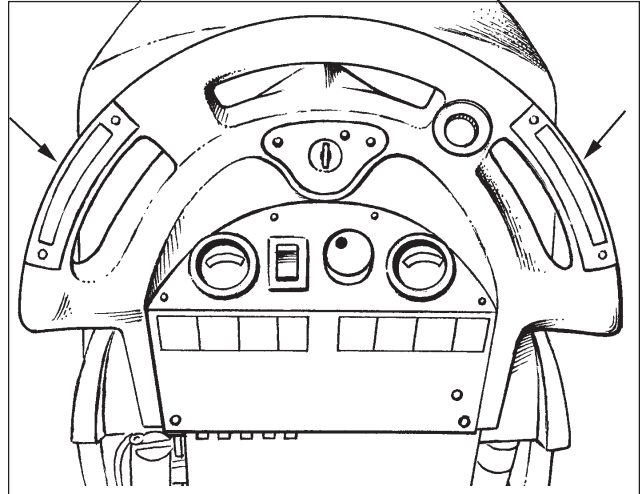
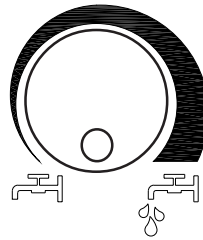

Figure #2

SYMBOLS USED ON ENCORE S2426 and L2426



Warning
("L Class" & "S Class")



Solution Control
("L Class" & "S Class")



Power
("L Class" & "S Class")

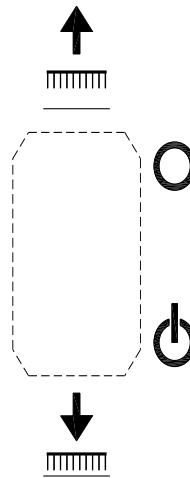

Brush Up/Down
("L Class" & "S Class")



Traverse Speed Control
("L Class")

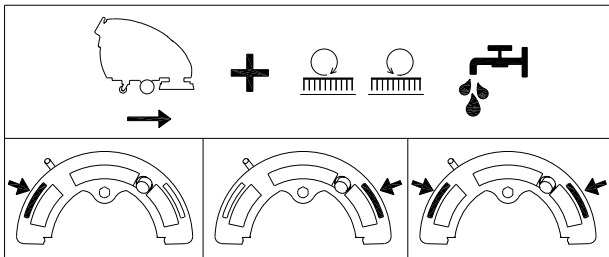

Traverse Directions Forward
(Traverse and Solution, and Brush Rotation)
("L Class")

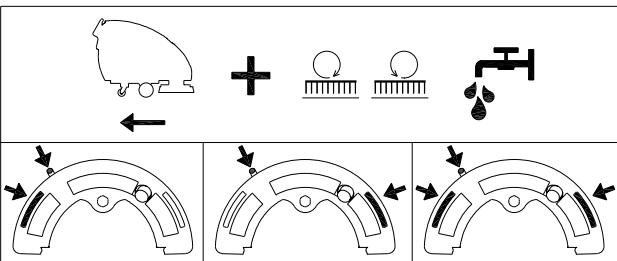

Traverse Directions Reverse
(Traverse and Solution, and Brush Rotation)
("L Class")

SYMBOLS USED ON ENCORE S2426 and L2426

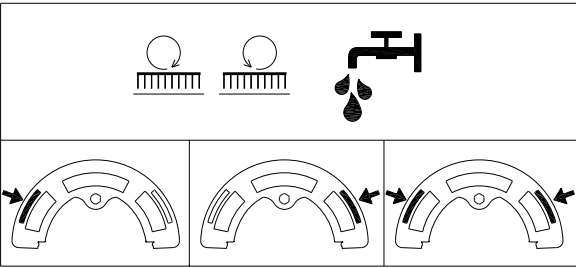

Solution/Brush Motors ("S Class")



Warning Label ("L Class" & "S Class") with parking brake



Warning Label ("L Class" & "S Class") without parking brake

Machine Control Panel

Key Switch (See Figure 3, Item "A")

The key switch turns "ON" the power to the control panel. "O" is "OFF" and "I" is "ON".

Forward Reverse Switch (See Figure 3, Item "B") On Traverse ("L") Model Only

The forward/reverse switch turns the traverse motor "on" forward and if the brush motors are in the down position, activates the brush motors/solution control module. There is a two second delay for the pad motor to stop after releasing the switch. Either the right or the left switch can be used. Use either switch in conjunction with the white reverse switch to reverse the traverse motor.

"S" Model - These switches activate brush motors and solution/control module if brush motors are in the down position.

Battery Meter (See Figure 3, Item "C")

The battery meter indicates the relative charge on the battery pack. Do not continue to run the machine when the needle is in the "red" area. This will shorten the life of the battery pack.

Brush Pressure Meter (See Figure 3, Item "D")

The pad pressure meter indicates the relative amount of pressure the pad is putting on the floor. To maximize run time on a battery charge, keep the needle towards the center of the green area.

Reverse Switch (See Figure 3, Item "E")

On Traverse Model Only

The reverse switch, when used in conjunction with one of the forward/reverse switches, causes the machine to reverse directions. The reverse speed is 70% of the forward speed.

Hour Meter (Not Illustrated) (Option)

The hour meter indicates the number of hours the machine has operated. It runs only when the brush motor is on.

Circuit Breakers (See Fig 3, Items "F", "G", "H", "I" & "J")

The circuit breaker reset buttons are located on the rear cover. The breakers are located as follows:

Item F - Actuator Head (5 amp)

Item G - Vacuum Motor (30 amp)

Item H & I - Brush Motor (40 amp)

Item J - Traverse Motor (25 amp) (L2426 only)

If a circuit breaker trips, determine which motor is not operating and turn the key switch "OFF". Wait five minutes and push the reset button back in. Turn the key switch "ON" and try again. An authorized service person should be contacted if the breaker trips again.

Control Handles (See Figure 3, Item "K")

The control handles are located at the rear of the machine. They are used to guide the machine.

Solution Control Knob (See Figure 3, Item "L")

The solution control knob regulates the flow of chemical solution to the floor. To increase the flow, turn knob clockwise. To decrease the flow, turn counter clockwise. Full counter clockwise is OFF and full clockwise is ON.

Traverse Speed Knob (See Figure 3, Item "M")

To increase speed, turn knob clockwise.

Brush Motor Switch (See Figure 3, Item "N")

To activate brush motor, push brush position switch to down position. Brush Motor and solution flow will activate when the traverse buttons are pushed. To shut brush motor off, hold brush position switch in up position until actuator stops.

Vacuum Motor Switch (See Figures 4 & 5, pg. 11)

To activate vacuum motor, lower squeegee handle. Handle has two positions. Lowest position is operating position and the middle position is transport to clear vacuum hose.

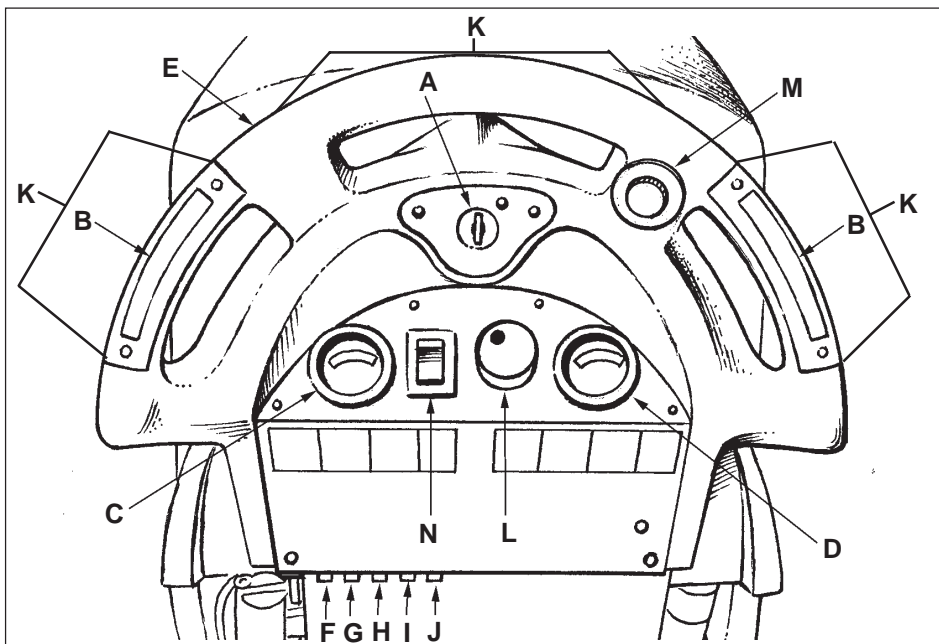

Figure 3

Machine Controls and Features

Squeegee Lift Handle, See Figures 4 and 5

The squeegee lift handle is located below the control handles in the center. It is used to raise or lower the squeegee. The vac motor is turned on when the handle is lowered to either the first or last position.

Float Shut Off, See Figure 6

The shut-off switch for the vac motor is located in the recovery tank. It automatically turns off the vac motor when the recovery tank is full. **NOTE: If excessive foaming occurs in recovery tank, defoamer must be added. Damage to vacuum motor could result from foam.**

Parking Brake (Optional), See Figure 7

NOTE: Parking Brake must be used if operating machine on greater than 2% gradient.

The parking brake prevents movement of the machine.

⚠ CAUTION: Do not activate the parking brake while the machine is moving.

"L" Model - The brake is located on the right hand side of the machine on the transaxle motor. Turn the key switch off or disconnect the power to the battery to apply the brake.

There is a mechanical lever located on the brake. This lever is an override. To manually release the brake, rotate the lever clockwise. To return the brake to normal or to apply the brake, rotate the lever up counter clockwise.

NOTE: If the lever is left in the override position, the brake will not function with the key switch, and the machine will not operate.

"S" Model - The brake is located to the left hand rear of the machine. Press pedal to activate brake and release pedal to disengage brake.

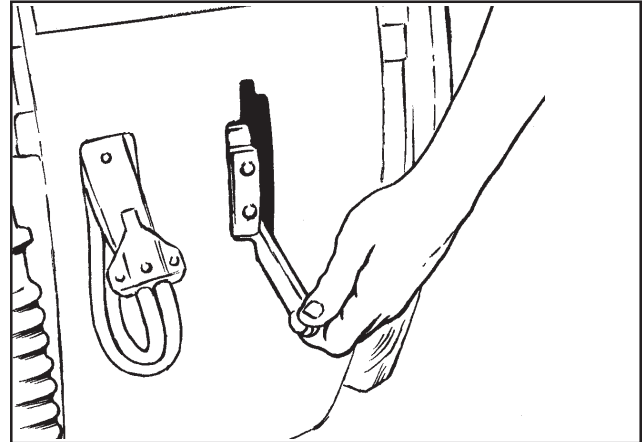

Figure 4

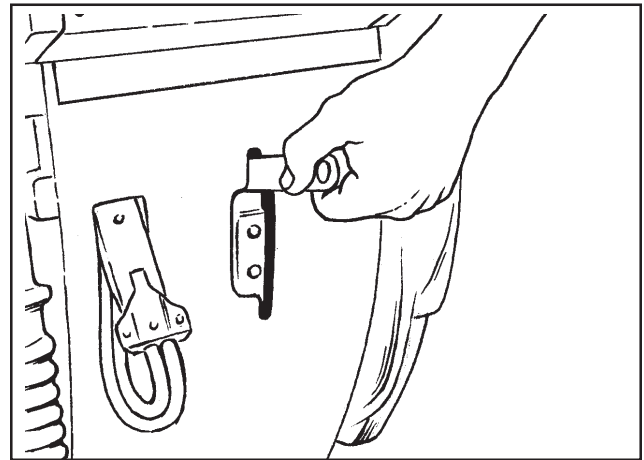

Figure 5

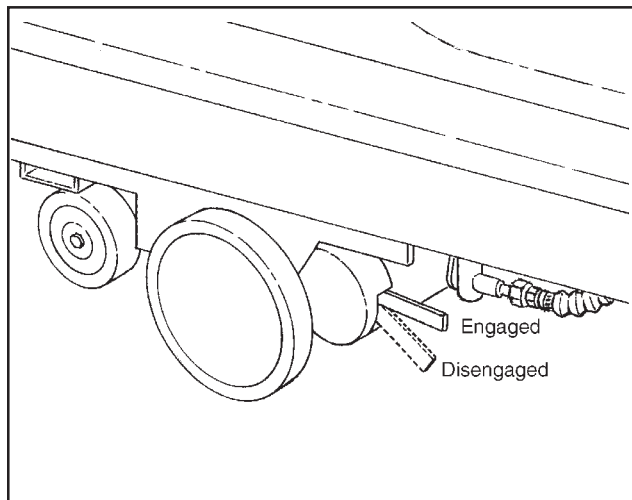

Figure 7

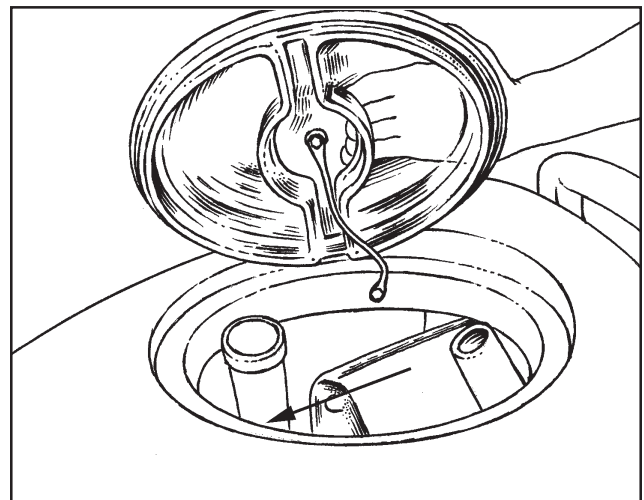

Figure 6

How To Prepare the Machine For Operation

How To Install The Batteries

The Encore machines uses either two 12-volt batteries or four - 6 volt batteries. The batteries are located in the battery compartment under the recovery tank.

To install the batteries, follow this procedure:

1. Turn machine off. Set brake (if equipped).
2. Make sure recovery tank is empty.
3. Tip up the recovery tank until it locks in the full open position. See figure 8A.

CAUTION: Before raising the tank, be sure tank is empty.

NOTE: There is an intermediate position available for holding the recovery tank open for charging batteries. See figure 8B.

WARNING: Do not operate or perform maintenance on the machine while the recovery tank is in the intermediate position. The tank can be accidentally bumped and it may slam shut.

4. Place the batteries in the tray as shown in figure 8C.

WARNING: The batteries are heavy. Lifting batteries without help could result in an injury. Get help to lift the batteries.

WARNING: Working with batteries can be dangerous. Always wear eye protection and protective clothing when working near batteries. **NO SMOKING!**

5. Connect the cables between batteries and install long battery cable assembly as indicated. See figure 8C.
6. Join the connector from the battery pack to the connector on the control panel. See figure 9.
7. Close recovery tank by pulling up on the latch arm and then slowly lowering the tank.

NOTE: Charge the batteries before using the machine.

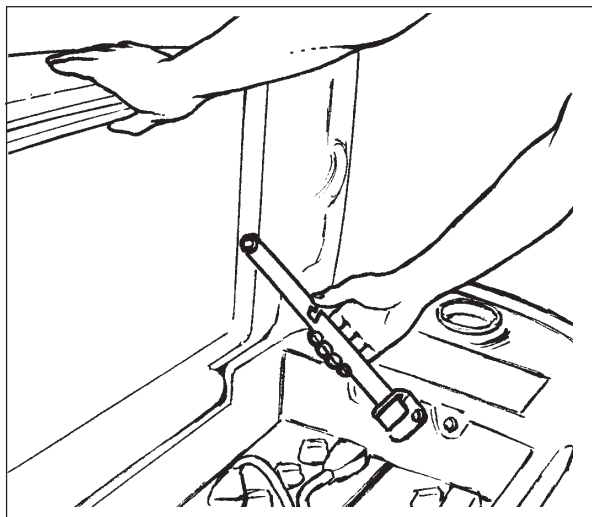

Figure 8A

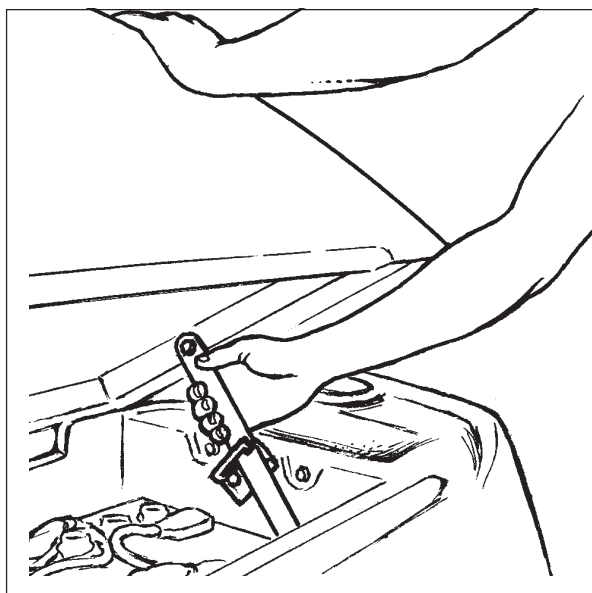

Figure 8B

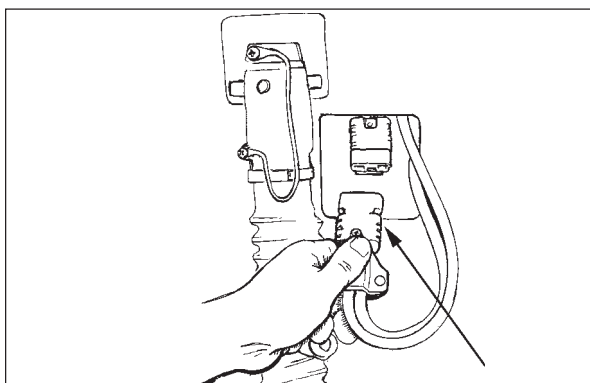

Figure 9

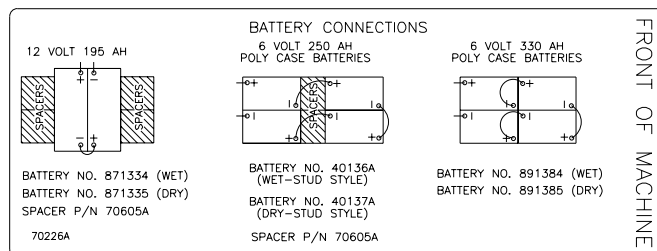

Figure 8C

How To Prepare the Machine For Operation

Battery Maintenance

The electrical power to operate the machine comes from the storage batteries. Storage batteries need preventative maintenance.

⚠ WARNING: Working with batteries can be dangerous. Always wear eye protection and protective clothing when working near batteries. **NO SMOKING!**

To maintain the batteries in good condition, follow these instructions:

1. Keep the electrolyte at the correct level. The correct level is between 1/4" (1/2 cm) below the bottom of the tube in each cell and above the tops of the plates. Check the level of the electrolyte each time you charge the batteries. See figure 10.

NOTE: Check the level of electrolyte prior to charging the batteries. Be sure the plates in each cell are covered with electrolyte before charging. Do not top off the cells prior to charging the battery. Electrolyte expands during charging. As a result, the electrolyte could overflow from the cells. Always top off the cells with distilled water after charging.

⚠ CAUTION: Irreversible damage will occur to the batteries if electrolyte does not cover the plates. Keep the electrolyte at the correct level.

⚠ CAUTION: Machine damage and discharge across the tops of the batteries can occur if the batteries are over filled. Do not fill the batteries up to the bottom of the tube in each cell. Wipe any acid from the machine or the tops of the batteries. Never add acid to a battery after installation.

⚠ CAUTION: Batteries must be refilled with distilled water only. Do not use tap water as it may contain contaminants that will damage batteries.

2. Keep the tops of the batteries clean and dry. Keep the terminals and connectors clean. To clean the top of the batteries, use a damp cloth with a weak solution of ammonia or bicarbonate of soda solution. To clean the terminals and connectors, use a terminal and connector cleaning tool. Do not allow ammonia or bicarbonate of soda to get into batteries.

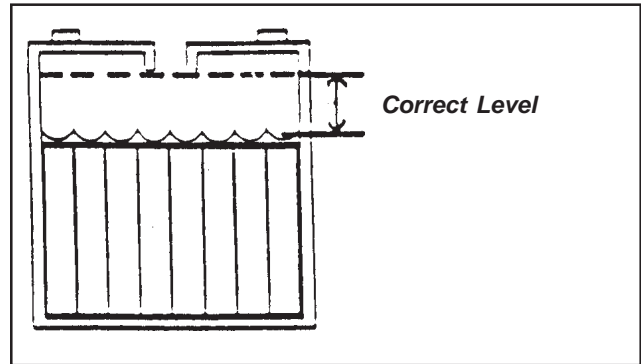

Figure 10

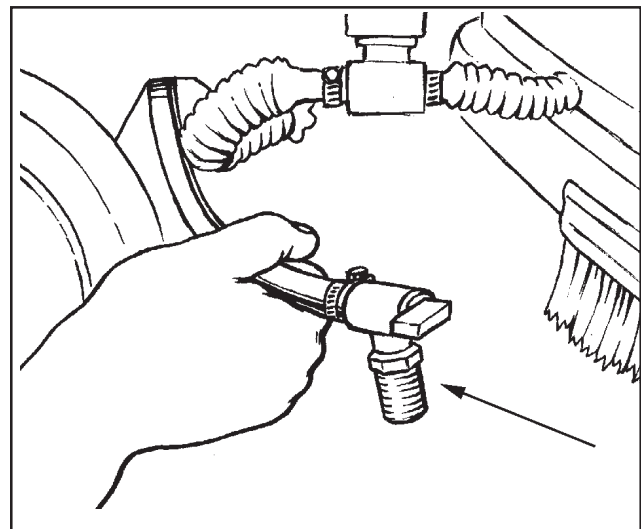

Figure 11

3. Keep the batteries charged.
4. To drain battery compartment: (See figure 11)
 - a. Always wear protective eye protection and protective clothing.
 - b. Add a weak solution of ammonia or bicarbonate of soda solution to battery compartment to neutralize any spilled acid.
 - c. Pull drain hose out from under transaxle.
 - d. Place hand behind flange and open valve.
 - e. When empty, close valve.
 - f. Replace valve and drain hose on top of transaxle.
 - g. Neutralize any acid spills with ammonia or bicarbonate of soda.

How To Prepare the Machine For Operation

How To Charge The Batteries

- ⚠ WARNING:** Charging the batteries in an area without adequate ventilation could result in an explosion. To prevent an explosion, charge the batteries only in an area with good ventilation.
- ⚠ WARNING:** Lead acid batteries generate gases which could explode. Keep sparks and flames away from batteries. **NO SMOKING!**
- ⚠ WARNING:** Failure to disconnect the AC plug from the wall receptacle before connecting or disconnecting the DC connector on the charger could result in an explosion. Always disconnect the AC plug from the wall receptacle before connecting or disconnecting the DC connector on the charger.

To charge the batteries, follow this procedure:

1. Put the charger on a flat surface. Make sure the vents on the sides are at least two inches away from walls and other objects. Make sure there are no objects near the vents on the bottom of the charger.
2. "L" Model - when key is off, brake is activated. Make sure key is off.

"S" Model - Set the parking brake (if provided) by putting it into the down position. See figure 12. Make sure the key switch is in "OFF" position.

3. Before charging the batteries the battery compartment needs to be vented. To vent compartment, tip up the recovery tank until it locks in either of the two open positions. See figure 13A. To close the tank, pull up on the latch arm and then slowly lower the tank to the closed position.

- ⚠ CAUTION:** Before raising tank, be sure tank is empty.

NOTE: There is an intermediate position available for holding the recovery tank open for charging batteries. See figure 13B.

- ⚠ WARNING:** Do not operate or perform maintenance on the machine while the recovery tank is in the intermediate position. The tank can be accidentally bumped and it may slam shut.

To place the tank in the intermediate position, pull up on the latch arm while raising the recovery tank until it slips into the knotch area of arm. While pulling up on the latch arm, carefully lower the recovery tank making sure it is securely locked into place. See figure 13B. To release the latch arm, tip the recovery tank up slightly while pushing down on the latch arm and then slowly lower the tank.

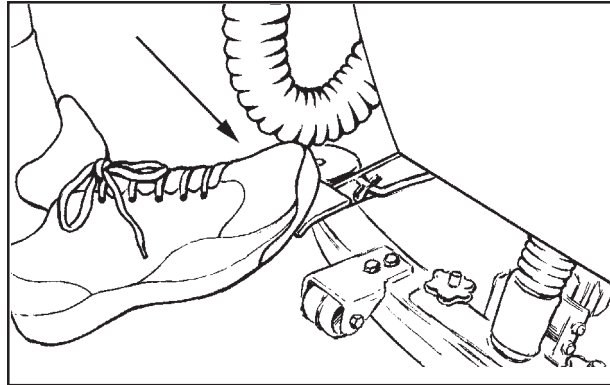

Figure 12
("S" Model)

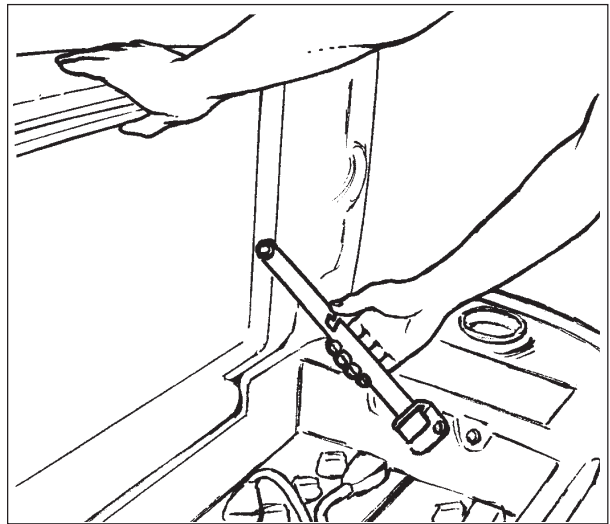

Figure 13A

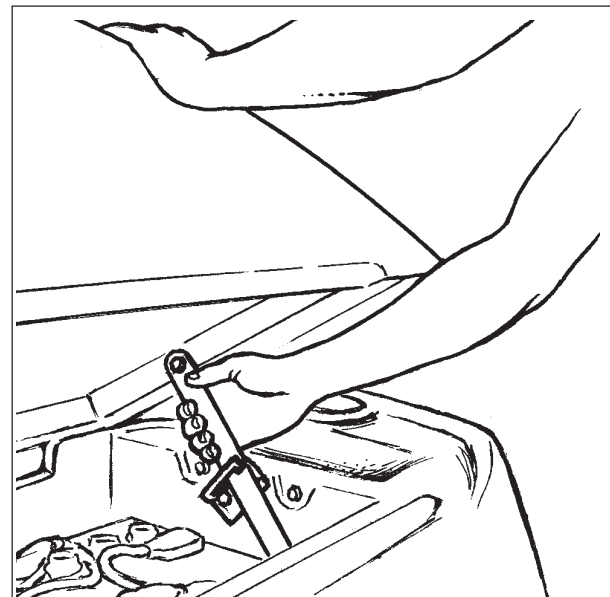

Figure 13B

How To Prepare the Machine For Operation

4. Disconnect the battery pack connector from the control housing connector. See figure 14A.
5. Connect the DC connector on the charger to the battery pack connector. See figure 14B.
6. Connect the charger to a properly grounded single phase (3-wire) wall receptacle having the input voltage, frequency, and ampere capacity specified on the nameplate of the charger.

For more information on the use of the charger, read the instructions supplied with the charger.

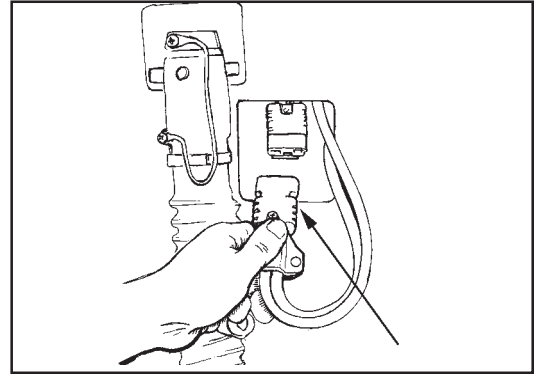

Figure 14A

How To Adjust Brush Cleaning Path from 24" to 26"

1. Insure brush head is in up position.
2. Turn the key switch "OFF" and remove the key.
3. Open front cover.
4. Raise plunger pin and rotate brush head. See figure 15.
5. Insure plunger pin is engaged in brush plate.
6. Close front cover.

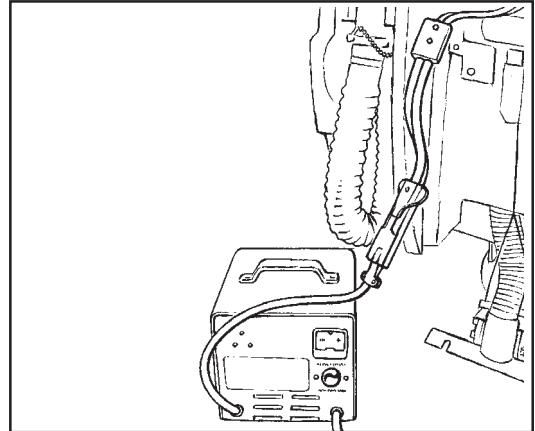

Figure 14B

How To Install The Brushes Or Pad Drivers

To install the brushes or pad drivers on the machine, follow this procedure:

1. Turn the key switch "ON".
2. Raise the brush head by pressing and holding the brush switch until brush head is in its full up position.
3. Turn the key switch "OFF" and remove the key.
4. Go to the front of the machine and unlatch front cover, swing cover open.
5. Unlatch right and left brush housings and remove them. See figure 16.
6. Put a brush or pad driver under the brush motor plate. See figure 17.
7. ("L" Model) Align the lugs on the motor gimbal with the slots in the brush gimbal.
("S" Model) Align the lugs on the motor with the slots on the brush gimbal.
8. ("L" Model) Pull the brush up until the gimbal locks.
("S" Model) Pull the brush up and rotate counter direction to scrub rotation, until lugs lock.
9. Repeat steps 6, 7, and 8 to install the second brush or pad driver.
10. Reinstall right and left brush housings and latch front cover.

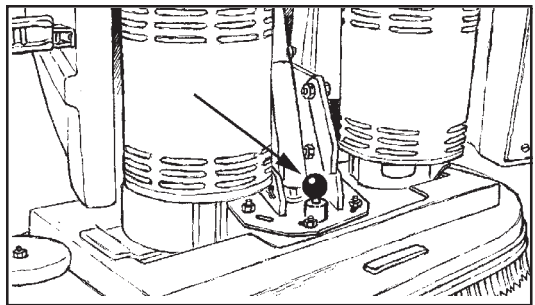

Figure 15

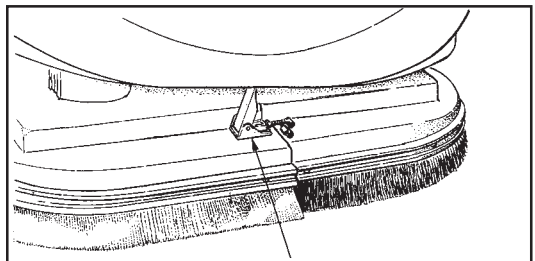

Figure 16

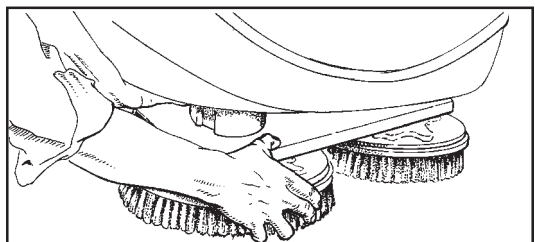

Figure 17

⚠ DANGER: Operating a machine that is not completely or fully assembled could result in injury or property damage. Do not operate this machine unless it is completely assembled. Inspect the machine carefully before operation.

How To Prepare the Machine For Operation

How To Remove The Brushes Or Pad Drivers

To remove the brushes or pad drivers from the machine, follow this procedure:

1. Turn the key switch "ON".
2. Raise the brush head by pressing and holding the brush switch until brush head is in its full up position.
3. Turn the key switch "OFF" and remove the key.
4. Go to the front of the machine and unlatch front cover. Swing cover open and unlatch the brush housings.
5. ("L" Model) Push down on two sides of the brush or pad driver until the gimbals release.

("S" Model) Rotate brush same direction to scrub rotation with a quick snapping action until brush releases.

6. Reinstall right and left brush housing and latch front cover.

⚠ DANGER: Operating a machine that is not completely or fully assembled could result in injury or property damage. Do not operate this machine unless it is completely assembled. Inspect the machine carefully before operation.

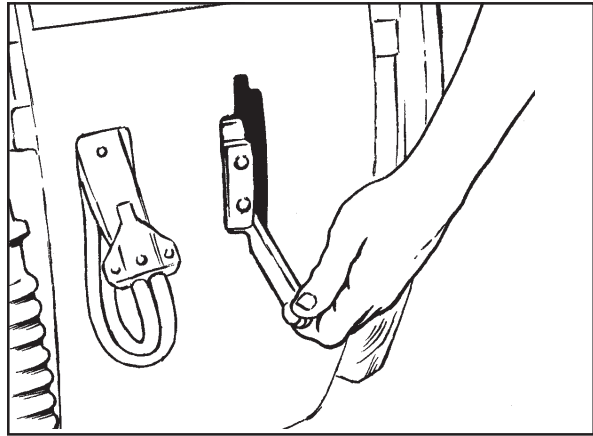

Figure 18

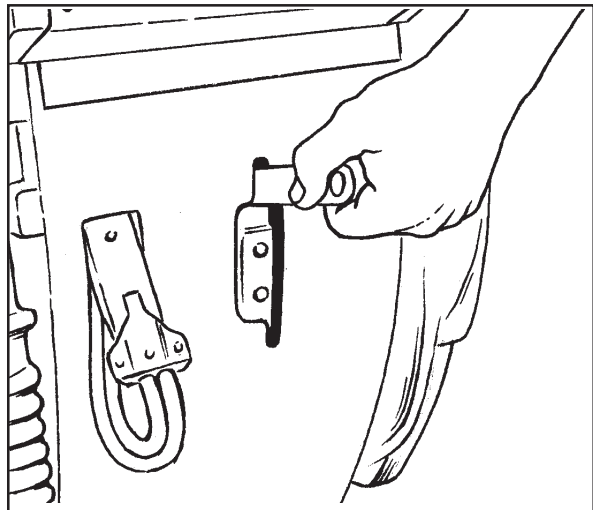

Figure 19

How To Operate The Machine

How To Operate The Squeegee

The squeegee wipes the floor while the vacuum motor removes the dirty solution from the floor. Use your hand to lower or raise the squeegee handle. To operate the squeegee, follow this procedure:

1. To lower the squeegee and start the vacuum motor, move the squeegee lever to the right and down. See figure 18.
2. To raise the squeegee, lift the squeegee lever up. See figure 19.

NOTE: The center position lets the vacuum motor continue to run with the squeegee off the floor to avoid drips and also allows you to back up the machine.

How To Fill The Solution Tank

The solution tank can be filled in the front or through the clear drain hose at the rear of the machine (See figure 20). To fill the solution tank follow this procedure:

1. Add a cleaning chemical to the solution tank. For the correct amount of chemical, follow the directions shown on the container.
2. Fill the solution tank with water. When filling machine in the front with a hose, position hose inside the fill screen as shown in figure 20A.

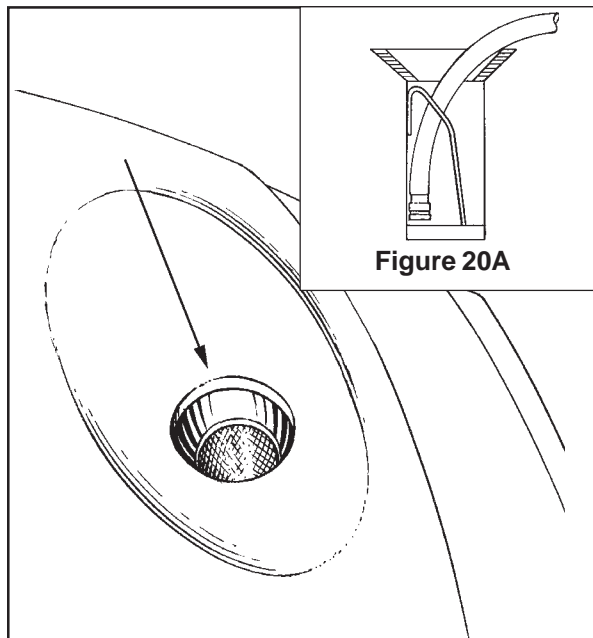

Figure 20

How To Operate The Machine

When filling machine from the rear, position clear drain hose against bracket and insert hose as shown in figure 20B. Solution level can be viewed from the back of the machine.

⚠ WARNING: Water solutions or cleaning materials used with this type of machine can leave wet areas on the floor surface. These areas can cause a dangerous condition for the operator or other persons. Always put CAUTION signs near the area you are cleaning.

⚠ WARNING: Machines can ignite flammable materials and vapors. Do not use with or near flammables such as gasoline, grain dust, solvents and thinners. Only use a cleaning concentration recommended by the chemical manufacturer.

⚠ WARNING: Clarke Technology recommends a maximum water temperature of 120°F (49°C).

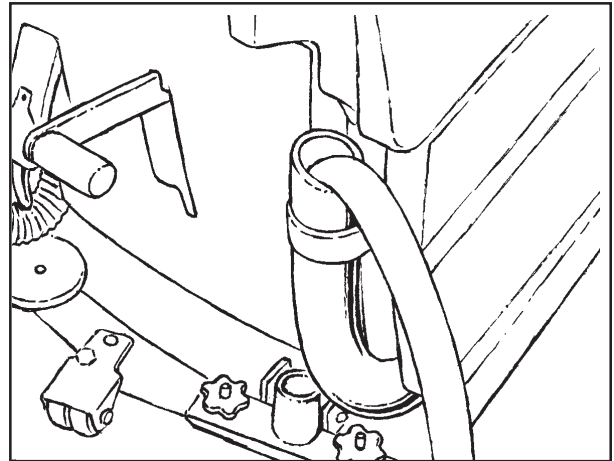

Figure 20B

Operating The Machine

NOTE: Put the machine in the lowest traverse speed setting. Use the machine in an area that has no furniture or objects until you can do the following:

1. Move the machine in a straight direction, forward and backward.
2. Stop the machine safely.
3. Turn the machine both left and right and return to a straight direction.

To move the machine, follow this procedure:

1. Release the parking brake (if equipped with machine).
2. Turn the key switch to the "ON" position
3. Raise the brush to the highest setting.
4. Raise the squeegee.
5. When either the left or right forward/reverse switches (figure 21, item A) are pushed in, the machine will go forward.
6. Control the speed of traverse by using the traverse speed control knob (figure 21, Item C).
7. To stop, release the forward/reverse switch.
8. To reverse the machine, push in the white reverse switch (figure 21 item B) and either the right or left forward/reverse switch (figure 21 item A) at the same time.
9. To stop, release the forward/reverse switch.
10. To turn the machine, push the rear of the machine to the side.
11. When you stop the machine, turn the key switch "OFF", remove the key and set the parking brake (if equipped).

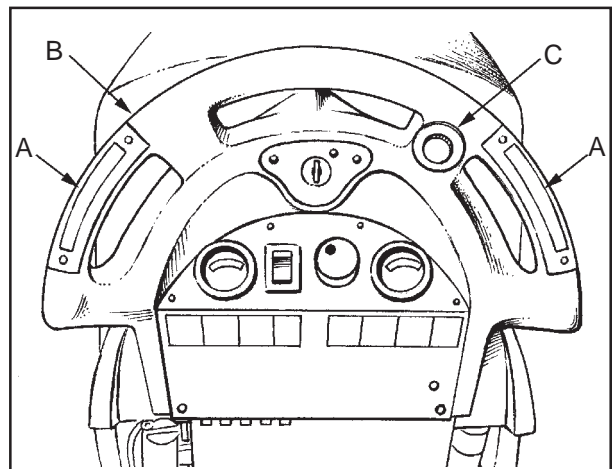



Figure 21

How To Operate The Machine (cont)

How To Clean A Floor

 **WARNING:** Water solutions or cleaning materials used with this type of machine can leave wet areas on the floor surfaces. These areas can cause a dangerous condition for the operator or other persons. Always put CAUTION signs near the area you are cleaning.

To clean a floor follow this procedure:

1. Set the parking brake (if equipped with machine.)
2. Put the water and a cleaning chemical in the clean solution tank.
3. Release the parking brake (if equipped with machine.)
4. Turn the key switch "ON".
5. Lower the squeegee.
6. Activate the brush switch until correct pressure is achieved.

 **WARNING:** This machine is capable of maximum head pressure with worn pads or brushes. With this feature, there is the possibility of exceeding the recommended brush pressure on new pads or brushes. This will either create reoccurring circuit breaker tripping or the possibility of lost traction and control. The brush switch should be activated to accomplish only enough brush pressure for the job. This will allow longer battery life and cleaning time.

NOTE: Keep the machine moving when the brush is rotating on the floor. Pre-wet brush/pad or keep light pressure on brush until solution flow is adequate to keep brush/pad from scratching the floor.

To pre-wet brushes you should first turn the speed knob to the lowest setting on the "L" model. Then on both the "S" and "L" models, lower brushes until brushes are just touching the floor. Activate the forward/reverse switch to start motor and solution flow.

7. Turn the solution knob to the right to activate the flow of solution. Adjust the flow of clean solution to the flow desired.
8. Move the machine across the floor in the forward direction.
9. Make a 180° turn.

NOTE: When you make more passes across the floor, let the brush clean approximately 2 inches (5 cm) of the area already cleaned by the brush.

NOTE: During most cleaning procedures, apply and remove the solution in one operation.

How To Clean A Very Dirty Floor

To clean a very dirty floor, follow this procedure:

1. Apply solution to the floor.
2. Do not lower the squeegee. This will keep the vacuum motor off.
3. Lower the brush or pad and scrub the floor.
4. Scrub the floor again with additional solution and lower the squeegee.
5. Pick up all the solution with the squeegee.

Maintenance

⚠ WARNING: Maintenance and repairs must be done by authorized personnel only.

⚠ WARNING: Always empty the solution tank and recovery tank before doing any maintenance.

⚠ WARNING: Keep all fasteners tight.

These Maintenance Procedures Must Be Done Every Day

Keep the machine clean, it will need fewer repairs and have longer life.

Do These Procedures When You Begin Your Work Period

1. Turn off key switch.
2. Disconnect AC power from battery charger (follow charger instructions).
2. Disconnect the plug on the battery charger from the battery pack connector.
3. Join the connector from the batteries to the control panel cable connection. See figure 22.
4. Make sure the Screen filter over the vacuum motor is clean and in position. See figure 24.
5. Make sure the recovery tank lid is on correctly. See figure 23, Item A.
6. Make sure the valve on the recovery drain hose is clean. Tightly close the valve.
7. Make sure the brushes/pads are in position and installed correctly.
8. Make sure brush housings and skirts are in position on the brush head.
9. Check the installation of the squeegee and squeegee hose.
10. Make sure the solution drain / level indicator hose is secure on the storage mount on the rear of the machine.

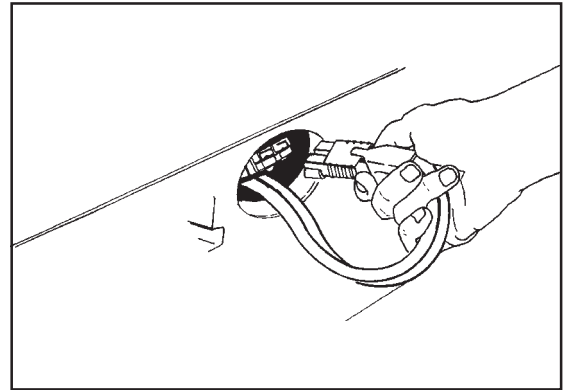

Figure 22

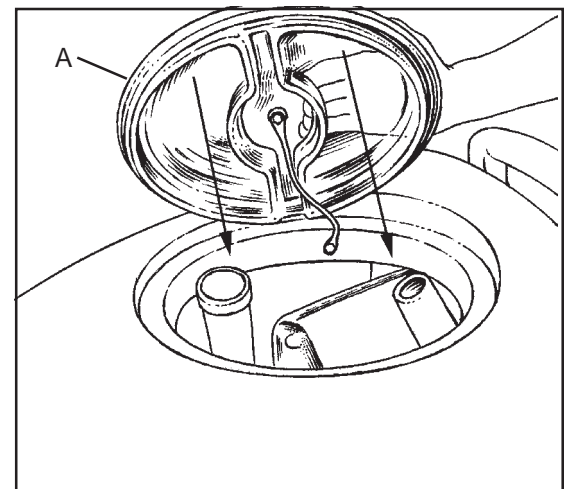

Figure 23

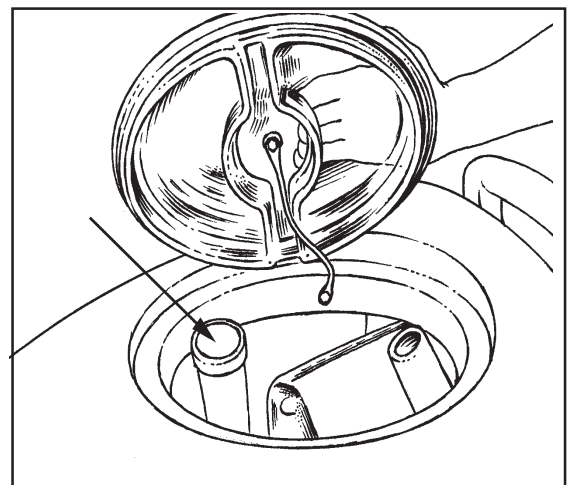

Figure 24

Maintenance

Do These Procedures When You End Your Work

1. Drain the solution tank (Figure 25) and the recovery tank (Figure 26). To drain the tanks, follow this procedure:
 - a. Turn the key switch "OFF".
 - b. Remove the drain hose from the back of the machine.
 - c. Put the end of the hose over a drain or bucket.
 - d. *Recovery Tank:*
 - 1.) Turn the valve handle to the left. Pull the handle out to open the drain (Figure 27).

NOTE: Have the opening in the side of the valve away from you when you open the valve.

- 2.) To open the valve completely, turn the handle to the right. Pull the handle out of valve (Figure 28).

Solution Tank:

When hose is lowered to water level, water will flow.

2. Flush the tanks. To flush the tanks, put clean water in the tank through the opening on top of the tank.
3. If a tank or drain hose has an obstruction, use a pressure water hose to flush the tank or hose. Put the water hose into the drain hose.
4. Leave the tanks and the recovery drain valve open to dry in the air.
5. Check the squeegee blade. Use a cloth to clean the squeegee blade. If the squeegee blade is damaged or worn, turn or replace the blade.
6. Check and clean the solution lid gasket. Use a mild cleaning solution and rinse the parts in clean water.

Check the batteries and if necessary add distilled water after charging. The correct level is within 1/4 inch (1/2 cm) of the bottom of the tube in each cell.

CAUTION: Tap water may contain contaminants that will damage batteries. Batteries must be refilled with **DISTILLED WATER ONLY**.

WARNING: Lead acid batteries generate gases which can cause an explosion. **NO SMOKING.** Always wear eye protection and protective clothing when working near batteries.

Use a clean cloth and wipe the surface of the machine.

Charge the batteries. See the instruction in the section of this book called "How To Charge The Batteries".

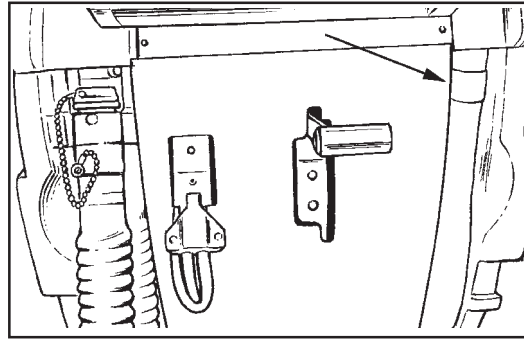

Figure 25

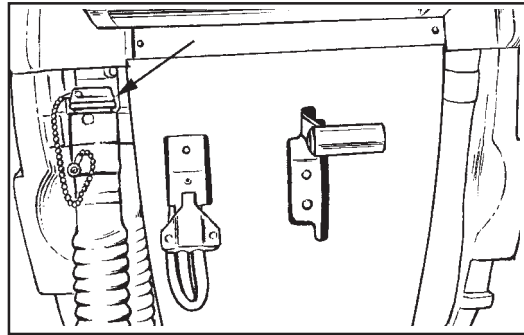

Figure 26

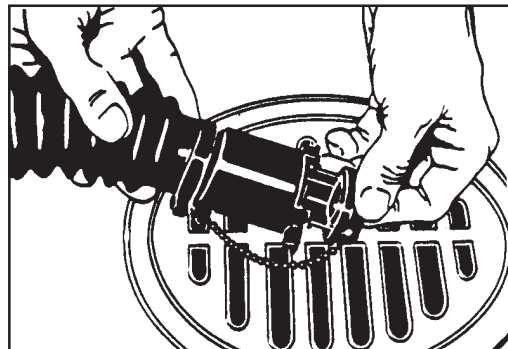

Figure 27

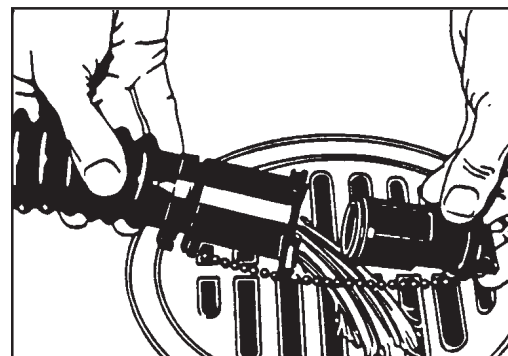

Figure 28

Maintenance

Maintenance Procedures To Be Done Every Week:

⚠ WARNING: Maintenance and repairs must be done by authorized personnel only. Always empty the solution tank and the recovery tank before doing any maintenance. Keep all fasteners tight.

⚠ WARNING: Always wear eye protection and protective clothing when working near batteries. Do not put tools or other metal objects across the battery terminals or the tops of the batteries.

⚠ CAUTION: To prevent damage to the machine, and discharge across the tops of the batteries, do not fill the batteries above the bottom of the tube in each cell. Wipe any acid from the machine or the tops of the batteries. Do not add acid to battery after installation.

NOTE: Always turn off key switch before servicing the machine.

⚠ WARNING: Always wear eye protection and protective clothing when working near batteries. **NO SMOKING!**

1. To inspect batteries, tip up recovery tank until it locks in the full open position. See figure 29A. To close the tank, pull up on the latch arm and then slowly lower the tank to the closed position.

⚠ CAUTION: Before raising the tank, be sure tank is empty.

NOTE: There is an intermediate position available for holding the recovery tank open for charging batteries. See figure 29B.

⚠ WARNING: Do not operate or perform maintenance on the machine while the recovery tank is in the intermediate position. The tank can be accidentally bumped and it may slam shut.

2. Disconnect the batteries. Use a cloth and a solution of ammonia or bicarbonate of soda to wipe the top of the batteries. Clean the battery terminals. Reconnect the batteries.
3. Check the hoses for leaks, obstructions and other damage.
4. Use a grease gun to lubricate the dual casters. See figure 30.

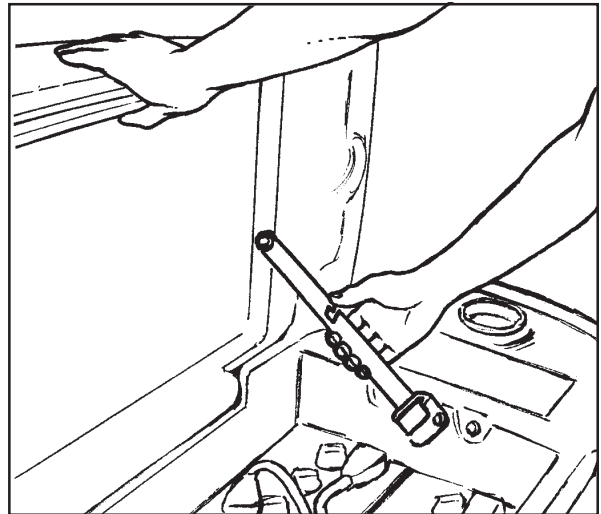

Figure 29A

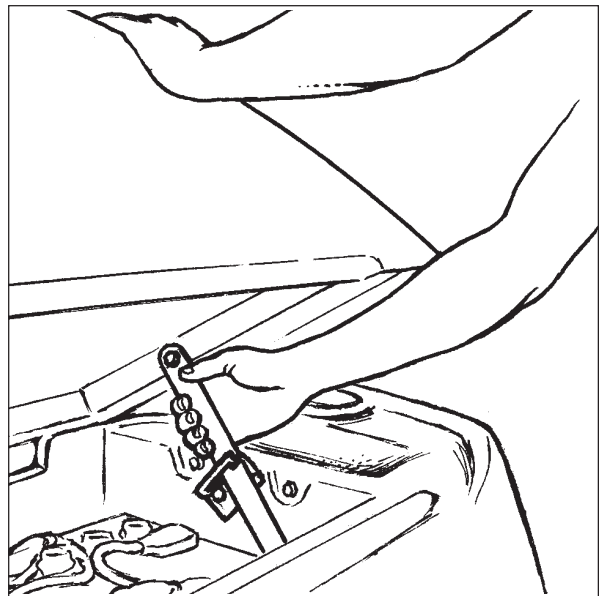

Figure 29B

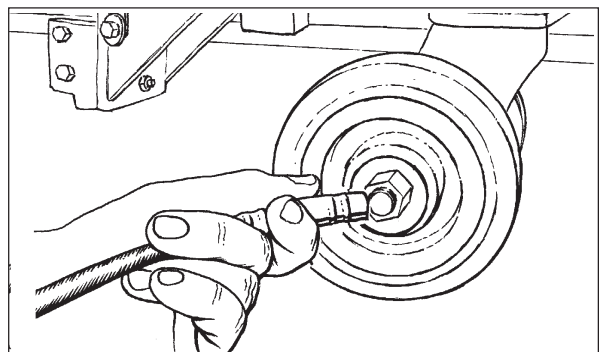

Figure 30

Maintenance

Maintenance For The Squeegee

To remove the squeegee, follow this procedure:

1. Remove the squeegee assembly by loosening the two knobs that attach the squeegee to the machine. Pull the squeegee assembly off. See figure 31.
2. Inspect the squeegee blade.
3. If the blade is worn, turn the blade so that a new edge is in the wiping position.
4. Reinstall squeegee assembly on the machine.

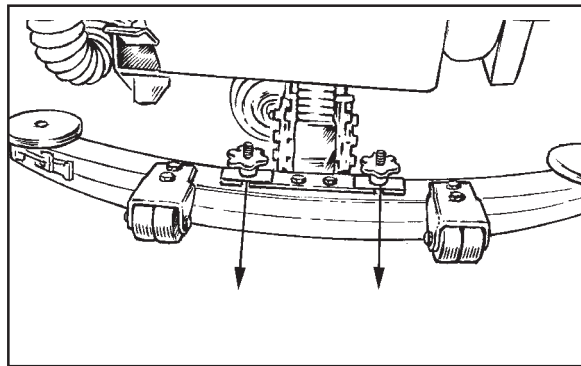

Figure 31

How To Adjust The Squeegee

The following adjustments are set at the factory, however they may require slight adjustment.

Adjusting Squeegee Tilt:

The tilt of the squeegee causes the rear blade to raise up in the center or on the ends, depending on which direction the tilt is changed. For tilt adjustment, refer to figure 32. Loosen left and right screw "X". In order to bring the blades down in the center, tip "Y" down. To bring both ends down, tip "Y" up. Make very small adjustments and try it until a uniform flare is achieved.

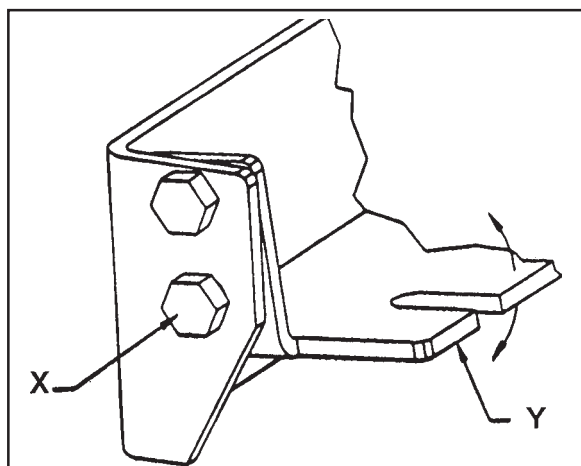

Figure 32

Adjusting Squeegee Blades:

When properly installed the front blade should be approximately 0.06" (1.5mm) above the rear blade. See figure 33.

⚠ WARNING: Maintenance and repairs must be done by authorized personnel only .

⚠ WARNING: Electrical repairs must be done by authorized personnel only.

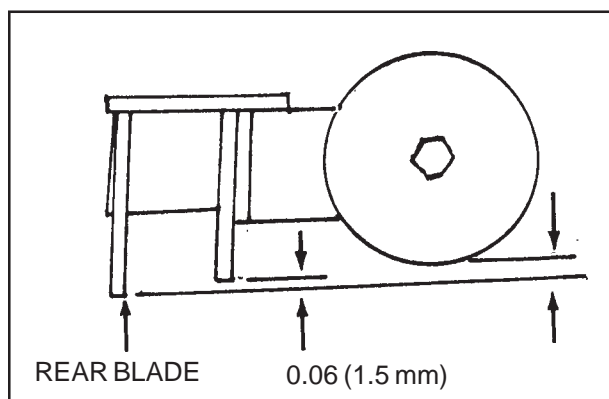

Figure 33

Maintenance cont.

Consult your Clarke Technology Authorized Service Person to do the service procedures.

Use only genuine Clarke Technology parts.

How to Center or Offset the Brush Head

The brush head on the Encore 2426 can be centered or offset 1 inch to the right side of the machine. To center or offset the brush head, follow this procedure:

Recommended tools: 3/8" drive ratchet, 3" extension and 9/16" socket.

CAUTION: Before offsetting the brush head, be sure that the recovery tank is empty of solution. Follow the instructions on page 20 on how to drain the recovery tank.

1. Turn the key switch "ON".
2. Raise the brush head by pressing and holding the brush switch until the brush head is in its full up position.
3. Turn the key switch "OFF" and remove the key.
4. Tip up the recovery tank until it locks in the full open position.
5. Go to the front of the machine and unlatch the front cover and swing cover open.
6. Locate the four mounting studs on the brush head bracket. See figure 34. The top two mounting nuts can be accessed through the top of the solution tank. The lower two can be accessed through the front. Loosen the four mounting nuts 2 to 3 turns counterclockwise. NOTE: Do not remove mounting nuts.
7. The brush head assembly can slide to the right side by one inch or placed back into the center. Slide the brush head assembly all the way to the ends of the slots for the desired position. This insures that the head operates straight up and down.
8. After repositioning the brush head, tighten nuts securely to approximately 236 inch-lbs.
9. Close the front cover.
10. Close the recovery tank.

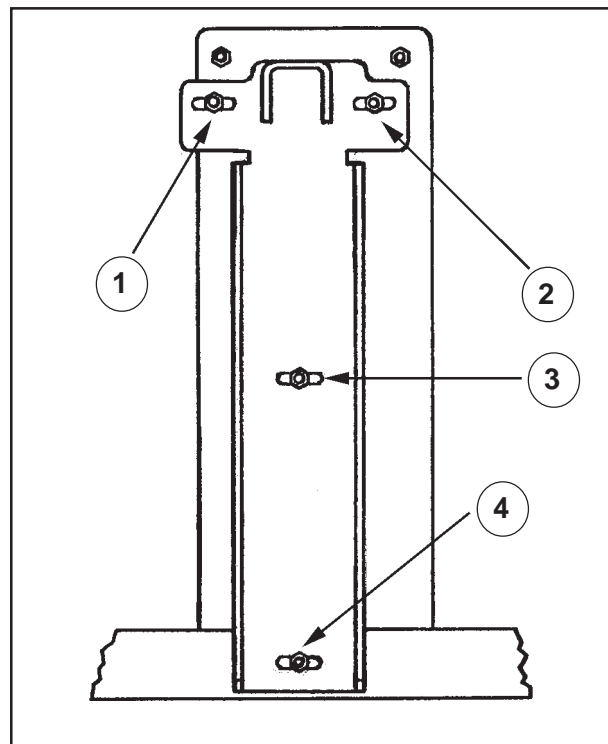

Figure 34

**Clarke Technology
Encore S2426 and L2426
Accessories - 6/02**

ACCESSORIES

| <u>Description</u> | <u>Part No.</u> |
|------------------------------------|-----------------|
| Power Wand System Kit | 10150A |
| Clarke Care Kit | 14607A |
| 39" Squeegee Assembly | 10068A |
| 32" Squeegee Assembly | 10129A |
| Poly Dur Protectant | 50478A |
| Kit, Grease Gun | 55420A |
| Kit, Low Voltage Shut-Off | 14097A |
| Brake Kit Assembly "L" | 10072A |
| Brake Kit Assembly "S" | 10073A |
| Accessory Bag | 30070A |
| Hour Meter Kit | 10656A |
| Soft Caster Assembly | 51092A |
| Gimbal, Brush "L" | 833802 |
| Gimbal, Brush Spring "L" | 838301 |
| Dual Direct Clutch Plate "S" | 30034A |
| Spacer for 30034A Clutch Plate "S" | 10143A |
| Center Lock Pad Retainer | 56941A |
| Kit, Solution Fill | 10177A |

Brushes and Pad Assemblies:

| <u>Size</u> | <u>Description</u> | <u>Part No.</u> (Gimbal "L") | <u>Part No.</u> (Clutch "S") | <u>Used For</u> |
|-------------|--------------------|---------------------------------|---------------------------------|-------------------------------|
| 13" | Polypropylene | 11438A | 10141A | General Scrubbing Hard Floors |
| 13" | Pad Driver Asm. | 17531A | 10140A | Use for Pads |
| 13" | Grit-Lite | 10382A | 10381A | |
| 13" | Clean Grit | 11439A | 10152A | |
| 13" | Super Grit | 11440A | 10153A | |
| 13" | Nylon Soft | 11437A | 10154A | |

Squeegee Blades:

| <u>Description</u> | <u>32" Assembly</u> | <u>39" Assembly</u> |
|-------------------------------|---------------------|---------------------|
| Blade, Rear - Gum Rubber | 30067A | 30069A |
| Blade, Rear - Nitrile Solid | 30081A | 30082A |
| Blade, Rear - Ribbed Orange | 30085A | 30086A |
| Blade, Front - Ribbed Natural | 30066A | 30091A |
| Blade, Front - Slit Grout | 30079A | 30080A |
| Blade, Front - Ribbed Orange | 30083A | 30084A |

CLARKE TECHNOLOGY
Encore L2426
Electrical Schematic (00950A-E) 5/01

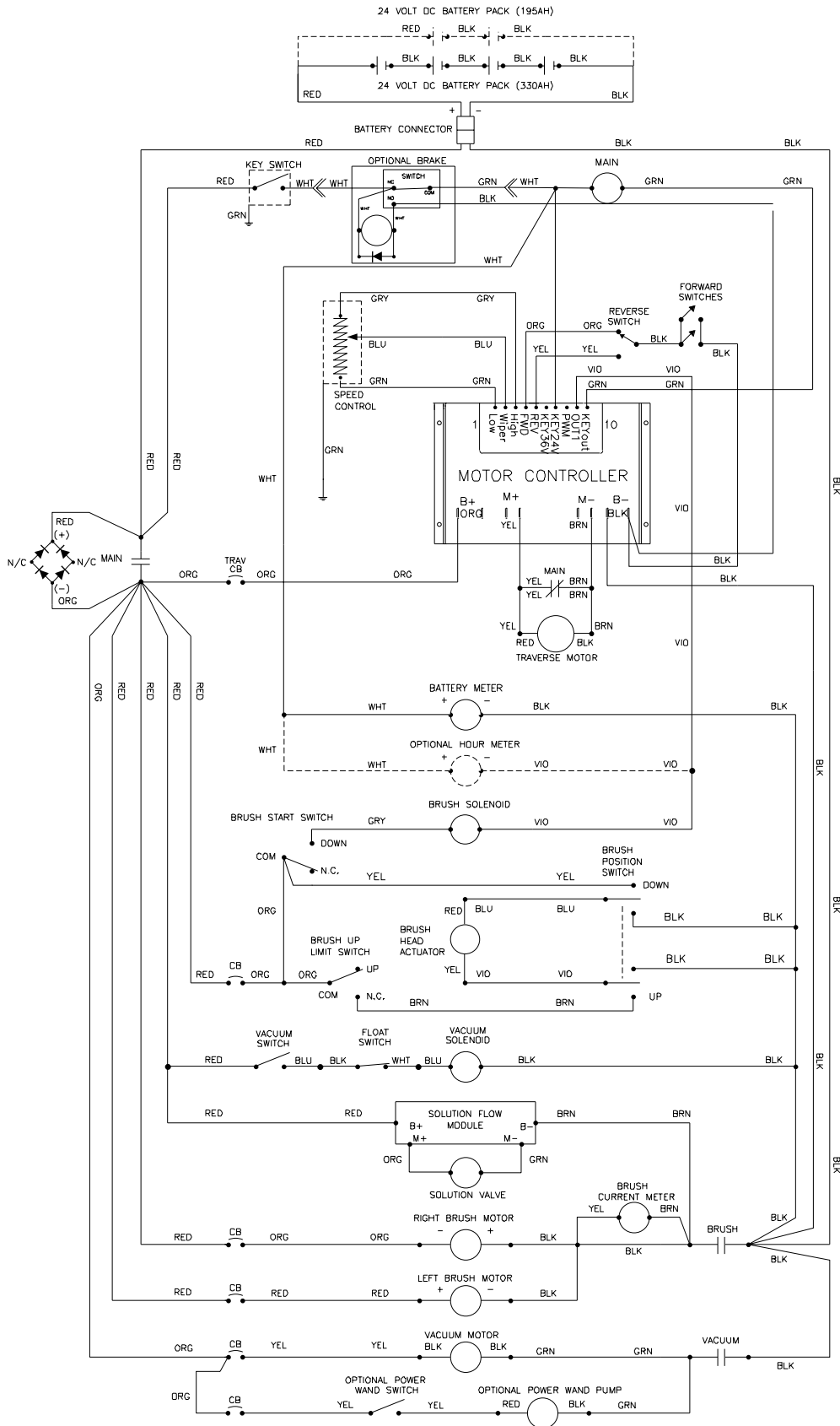

ALL BRUSH SWITCHES ARE SHOWN IN THE BRUSH HEAD UP POSITION.

ALTO PRODUCT SUPPORT BRANCHES

U. S. A. Locations

PRODUCTION FACILITIES

Clarke®, Springdale, Arkansas
2100 Highway 265
Springdale, Arkansas 72764
(479) 750-1000
Customer Service - 1-800-253-0367
Technical Service - 1-800-356-7274

American Lincoln®, Bowling Green, Ohio 43402
1100 Haskins Road

SERVICE FACILITIES

Clarke®, Elk Grove, Illinois 60007
2280 Elmhurst Road
(847) 956-7900

Clarke®, Denver, Colorado 80204
1955 West 13th Ave.
(303) 623-4367

Clarke®, Houston, Texas 77040
7215 North Gessner Road
713-937-7717

SERVICE AND SALES FACILITY

American Lincoln® / Clarke, Madison Heights,
Michigan 48071-0158
29815 John R.
(810) 544-6300

American Lincoln® / Clarke, Marietta, Georgia 30066
1455 Canton Road
(770) 973-5225

SALES AND DISTRIBUTION CENTER

Clarke®, Secaucus, NJ 07094
74 Henry Street
(201) 864-5503

Clarke®
Clarke American Sanders
A.L. Cook
Customer Service Headquarters and Factory
2100 Highway 265
Springdale, Arkansas 72764
(479) 750-1000
Technical Service
1-800-356-7274

European Locations

PRODUCTION FACILITIES

ALTO Danmark A/S, Aalborg
Blytaekkervej 2
DK-9000 Aalborg
+45 72 18 21 00

ALTO Danmark A/S, Hadsund
Industrikvarteret
DK-9560 Hadsund
+45 72 18 21 00

SALES SUBSIDIARIES

Clarke® Canada Ltd., Rexdale Ontario
24 Constellation Ct.
(416) 675-5830

ALTO Overseas Inc., Sydney (Australia)
1B/8 Resolution Drive
Caringbah NSW 2229
+61 2 9524 6122

ALTO Cleaning Systems Asia Pte Ltd., Singapore
No. 17 Link Road
Singapore 619034
+65 268 1006

ALTO Deutschland GmbH, Bellenberg (Germany)
Guido-Oberdorfer-Straße 2-8
89287 Bellenberg
+49 0180 5 37 37 37

ALTO Cleaning Systems (UK) Ltd., Penrith
Gilwilly Industrial Estate
Penrith
Cumbria CA11 9BN
+44 1768 868 995

ALTO France S.A. Strasbourg
B.P. 44, 4 Place d'Ostwald
F-67036 Strasbourg
Cedex 2
+33 3 8828 8400

ALTO Nederland B.V.
Postbus 65
3370 AB Hardinxveld-Giessendam
The Netherlands
+31 184 677 200

ALTO Sverige AB, Molndal (Sweden)
Aminogatan 18
Box 4029
S-431 04 Molndal
+46 31 706 73 00

ALTO Norge A/S, Oslo (Norway)
Bjornerudveien 24
N-1266
+47 2275 1770